

Quality
**ALUMINIUM
SYSTEMS**



BIFOLD DOORS

Aluminium bifolding doors create a visually stunning addition to your home and can add huge value.

Thermal performance and slim profile sections to minimise the visible framework and maximise the glass area, is key to their design.

Engineering grade hardware allows for silky smooth opening and closing operation.

What's more, all our doors come with a 10-year manufacturers' guarantee for your complete peace of mind.



Why choose Aluminium?

- ✓ Aluminium is extremely durable and hard-wearing. You'll be able to enjoy your aluminium doors for not only years but decades to come as they're incredibly resistant to the elements.
- ✓ It is an incredibly strong material, providing a high level of security.
- ✓ Aluminium doors are among the best-insulated on the market, thanks to advanced thermal break technology.
- ✓ They require very little maintenance to ensure optimal performance and to keep them looking good as new.



Whether it's a single door, French door, bifold door or bifold window, they can all be fabricated using our optimised aluminium bifold system. We can cater for projects that call for shaped frames, fixed frames, sidelights, astragal bars and blinds in glass.

All our products can be finished in several glazing options to create a style to suit any property. Single doors, French doors, bifolding doors and windows, or shaped and fixed frames are all available with the following glazing options:

- Double glazed
- Triple glazed
- Integral blinds
- Heritage look astragal bars

Our aluminium sashes are available in 3 profile designs: square, textured square and curved. Choose square for a classic look or textured square for a more contemporary alternative. And, if you're looking to complement your property's existing curve edged windows, then opt for our newest addition, the curved sash.



10 Year Guarantee

Manufactured in the UK

Ultra Slim Sightlines

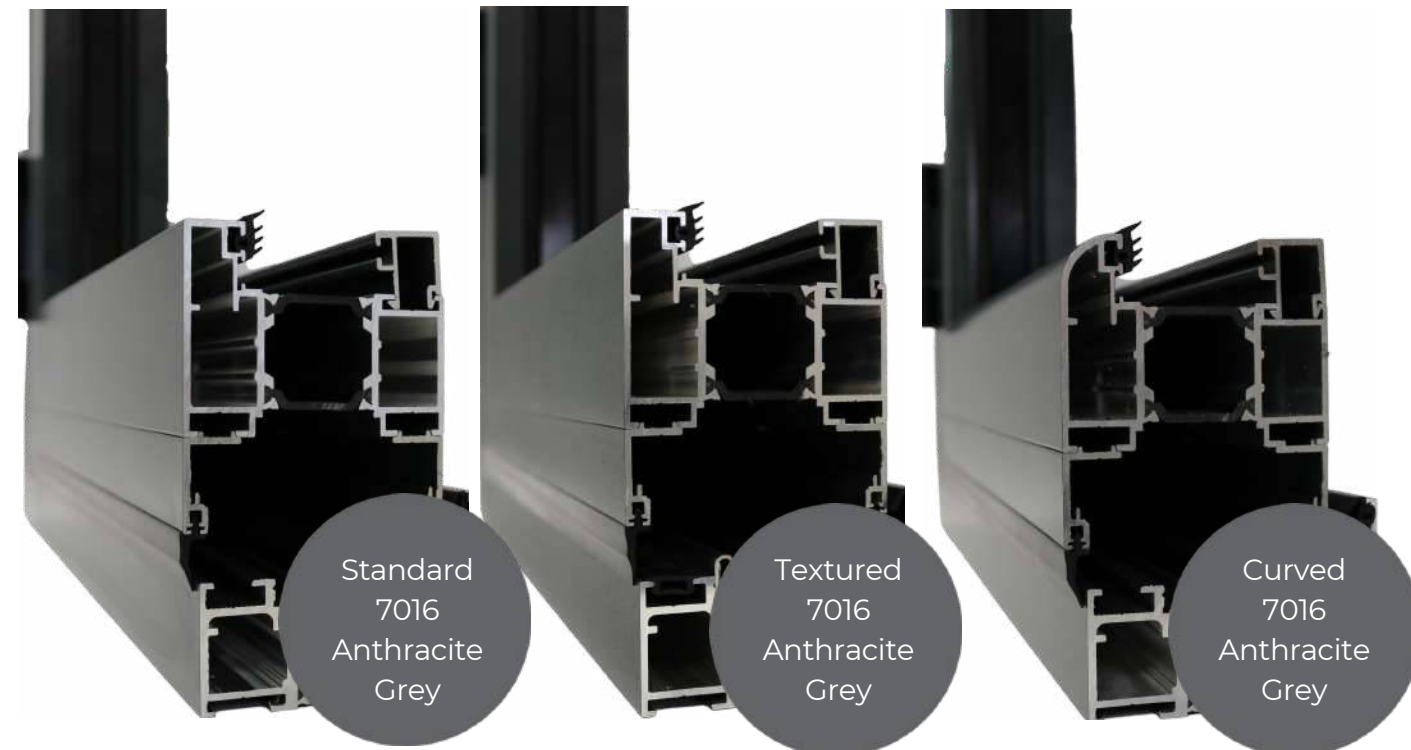

Standard 7016 Anthracite Grey

Textured 7016 Anthracite Grey

Curved 7016 Anthracite Grey



Bifold Windows



Installed by CGS Glazing

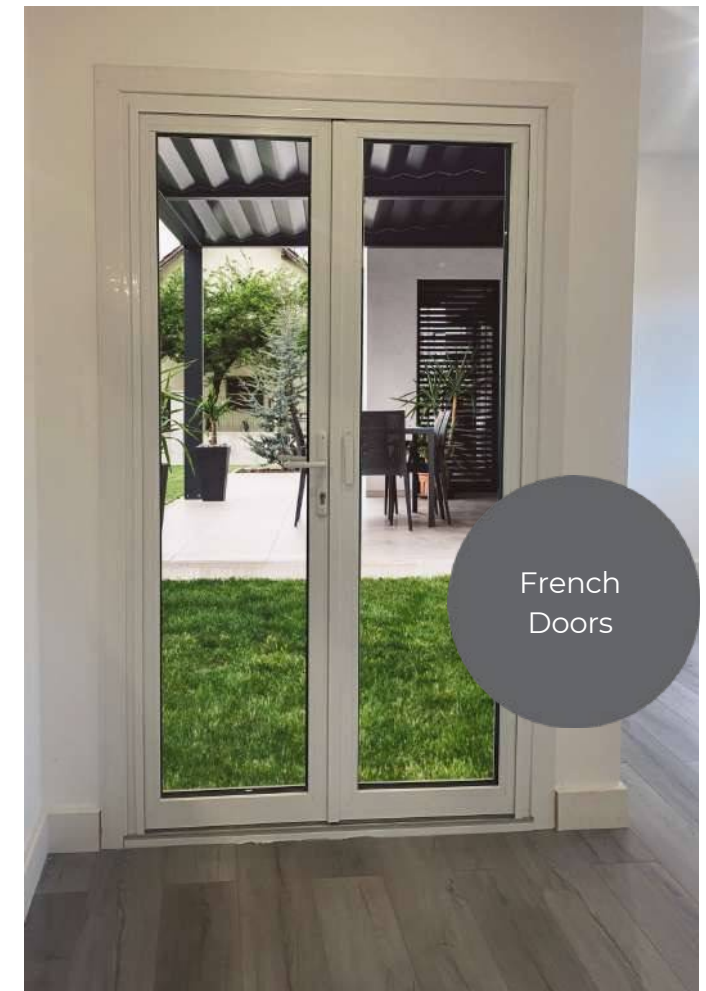

French Doors

GLAZING OPTIONS

We offer a wide variety of glazing options with our bifolds. Each varies in benefits including noise reduction and thermal properties, to including solar control coatings or blinds in glass. Ratings given below are based on glass U-Values.

Low E Double Glazing

Double glazing with toughened clear Low-Emissivity filled with argon gas which has a U-Value of 1.2 wkm2.

Standard

Ultra Low E Double Glazing

This is a great alternative to triple glazing, which can make doors heavy to use due to the extra weight. Ultra Low E has the same U value as triple glazing (1.1wmk2).

Triple Glazing

Our triple glazed units offer optimum protection and thermal efficiency benefits, achieving a U-Value of 1.1 W/m2K.

Solar Control Glass

This type of glass uses a solar control coating, which is blue tinted, to give protection against UV rays which can cause damage over time in sunny areas to items such as furniture. It can deflect the sun rays to help overheating in sun trap areas when your doors are closed.

Patterned Glass

We have a number of patterned glass options available. If you have one in mind please let us know, as the price and specification depend on the option.

Industrial Style



Transoms

Adding transoms to your design is the perfect way to achieve a popular modern-industrial look with your doors. Each pane of glass is cased in its own aluminium frame for an appealing visual effect.

This timeless style can be a great addition to any home, and made unique with a range of colour options and configurations.



Astragal Bars

Astragal bars offer a stylish and cost-effective option to creating industrial-style bifolds, French doors, single doors and bifolding windows.

To create this stunning door design, bars are added both within and atop the glass for a complete industrial look.

Make the design your own by adding your desired number of astragal bars both vertically and horizontally across each pane of glass.

Integral Blinds

Integral blinds can also be incorporated between the double-glazed units, which means they won't get damaged and will never need cleaning. The blinds provide can be supplied in a range of colours, as well the option of a Venetian or pleated blind.

There are three different methods of operation for the Uni-blinds, depending on your requirements and budget:

- Solar Power Uni-blinds
- Electric
- Magnetic Slider

Integral Blinds are offered with a five year manufacturing guarantee against faults. We use Morley Glass, widely recognised as the best quality blinds in glass units available.

Manually operated blinds utilise a magnetic device to allow the blinds to be adjusted with ease however required. Available for both Venetian and pleated integral blinds.



Venetian blinds can also be motorised and come with either a wall mounted button or remote control, operating an individual blind or synchronised for up to 12 blinds at once. These can either be wired into the mains or supplied with batteries and solar panels to recharge them.



Pleated available colours:
Pleated blinds come in a range of bold colours each with varying degrees of light reflection.

Venetian available colours: Venetian blinds offer increased light and solar reflection and come in a range of pastel shades and greys.

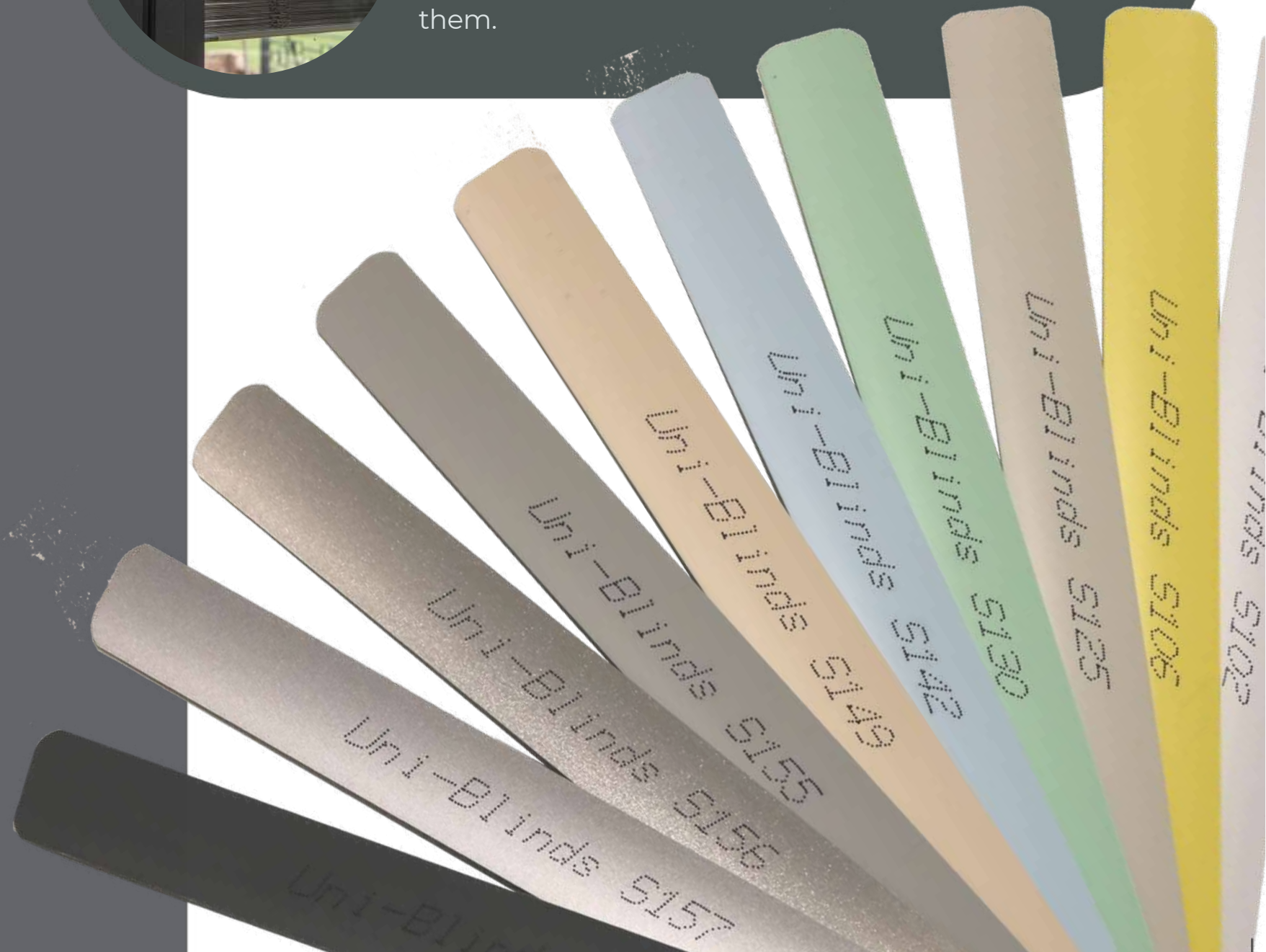

Cills and Thresholds

Our matching aluminium cills help to direct the elements away from areas prone to damp underneath the bifold. Cills are available in sizes of 90mm, 150mm, 190mm and 230mm. Standard 150mm without pre-drilled screw ports in White and Black. uPVC end caps available for standard 150mm cill.

Standard Threshold

Our Standard Threshold (55mm) provides the utmost protection whilst still looking sleek. The standard threshold acts as a full weather break, keeping your home dry and warm regardless of outside elements.

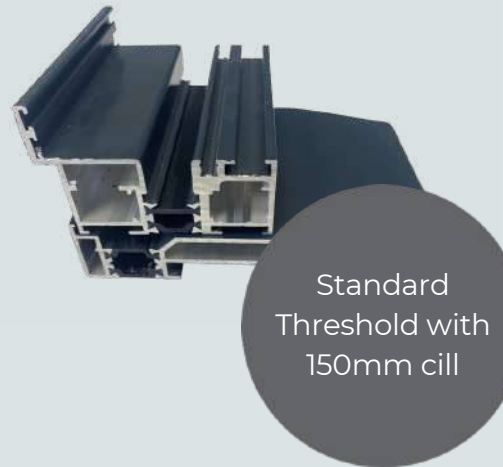

Low Threshold

Our Low Threshold (20mm) doesn't offer as much weather protection but creates a seamless look. Lower thresholds are less of a trip hazard than higher ones so are more suited for those with mobility issues or small children. While the design may be more striking, we don't recommend this for external bifolds unless in sheltered areas.

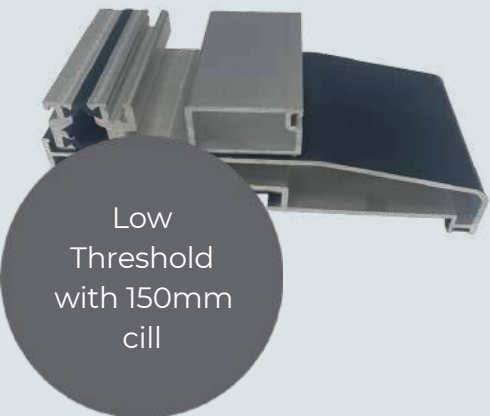

Low Threshold with Rebate

A 20mm rebate can be attached to our low threshold, making it only slightly higher at 40mm. The lip of the rebate gives extra weather protection against the elements.

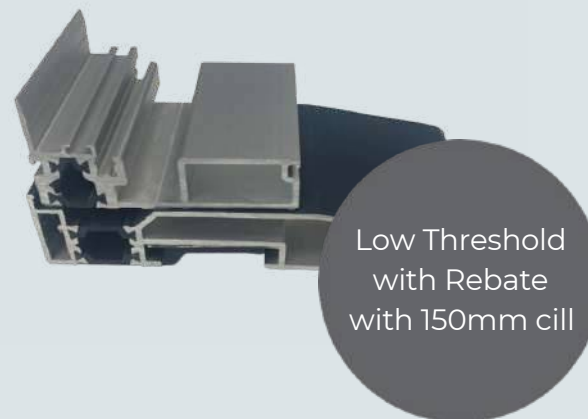

Available in any colour

PAS24 Compliant

Up to 14 leaves

Colours

Our doors are available in three standard colours, plus two dual colour options.

For projects requiring bespoke coloured doors, any RAL colour can be available upon request.

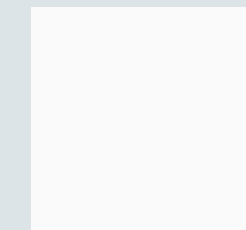

White
RAL9016



Grey
RAL7016

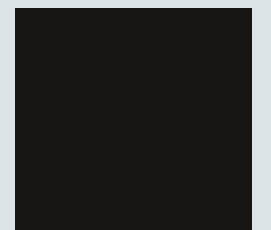

Black
RAL9005

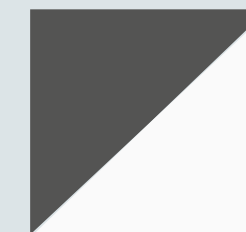

Grey Out/
White In



Black Out/
White In

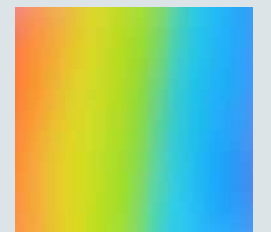

Bespoke
RAL colour

AluLock is the ultimate security kit that combines a euro profile cylinder as standard, with the option to upgrade to the Ultion 3-star barrel, with the Brisant Sweet Handle and an exclusively designed Duplex Double Hook Lock.

Ultion Stays Locked

The Ultion 3-star barrel provides double the sacrificial protection, made from materials 25% denser than iron and with twice the number of pins than the average lock (including an antipick pin) and 20-point drill protection as standard. If attacked, the barrel enters 'lockdown mode', meaning the lock is practically impenetrable without heavy and noisy power tools. Brisant are so confident of this that they will pay £2000 direct to the homeowner should a burglary take place within 10 years from the point of installation and entry was achieved by snapping an Ultion lock.

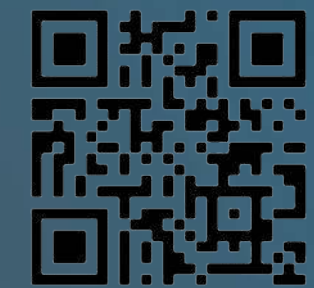

BRING THE ULTION
TECHNOLOGY
TO LIFE >



The Sweet Handle

The safe and stylish Sweet Handle is impressively durable, carrying multiple coatings of brass and nickel to ensure robust performance against the elements. Brisant also offers a 10-year direct to homeowner anti-corrosion guarantee for peace of mind.

The sleek curved design is not only pleasing to the eye but is an impressive security feature, stopping gripping tools designed to snap off handles during break ins.

Available in a range of colours including; black, white, grey, chrome and stainless steel. Gold and rose gold also available.



Duplex Double Hook Lock

The Duplex Double Hook Lock has been designed by UK-based Ingenious' highly experienced and dynamic design team, providing a 6-point locking system instead of 3-hook, for additional security. It comes with a dual follower to allow twin spindle function, which prevents unauthorised entry when the lock is in a latched position.

CREATE YOUR PERFECT BIFOLD

Maximum Vision

The Alutech BF73 Door System gives one of the largest sash sizes available, with up to 1200mm width and 3000mm height per pane.

Paired with super slim sightlines, you'll get the best uninterrupted views.

Weather Resistance

Excellent weather sealing is achieved using specially designed perimeter seals, with the option of weather piles for lower thresholds. Weather-tightness tested to British standards.

Low Maintenance

Our low-maintenance aluminium doors are strong, durable and highly corrosion-resistant. Unlike timber, they don't need painting or staining to keep them weather-proof, and they won't rust or corrode. They will also never rot, peel or flake.

10 Year
Guarantee

PAS24 Compliant
Locking System

UltraSlim
Sight lines



Floating Corner Post

The floating corner post option enables our right-angled bifolding doors, including the return, to open out fully, with the option of a fixed corner, for the ultimate wow factor!

(Structural support needs to be in place.)

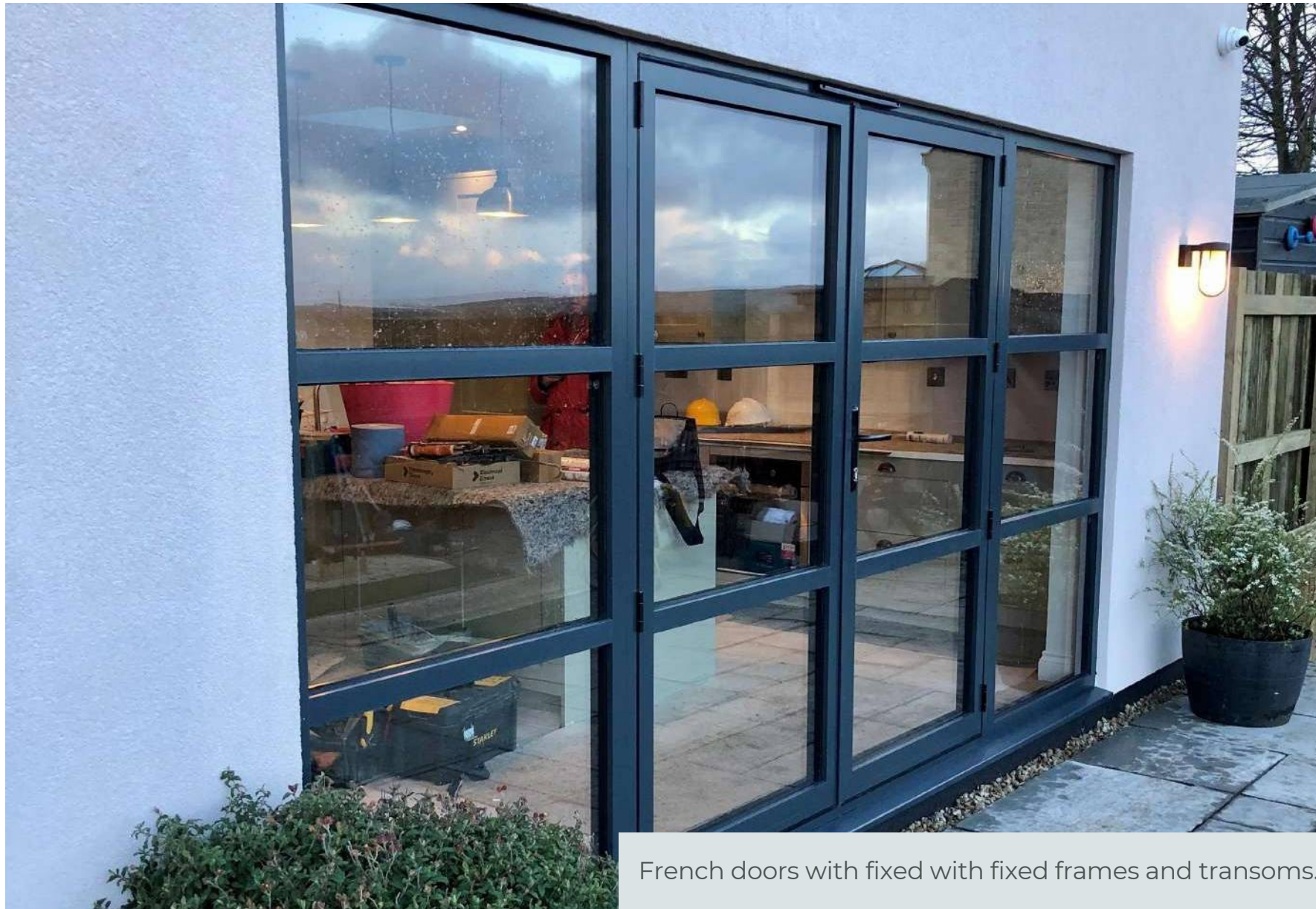

French doors with fixed with fixed frames and transoms.

Technical details at a glance:

- Market-leading maximum sash size of 1200mm x 3000mm.
- Maximum vision – minimal sight lines.
- Maximum security – PAS 24 compliant.
- Maximum insulation value – down to 1.4 U W/m²K.
- Maximum weather proofing – tested to BS6375 Part 1 : 2009.
- Single or dual colour. Factory powder coated to marine quality as per Qualicoat regulations.
- 120kg per door leaf providing for the openings.
- Engineering grade running rollers for a smooth and silky opening and closing operation.
- Trickle vents can be added.

Door leaf configuration

Our doors are available in up to 7 leaves each way (14 total). The leaves are able to open either from the left or right of the opening, either opening towards the inside of the property or to the outside – the choice is yours.

If ordering an even number of panes (e.g. 2 or 4) all sliding in the same direction, there will be no master door or external access.

Open out configurations

	TOTAL No OF PANELS
1LO outside 2LO outside 1L1RO outside 3LO outside 2L1RO outside	1 + 2 + 3
4LO outside 3L1RO outside 2L2RO outside	4
5LO outside 4L1RO outside 3L2RO outside	5
6LO outside 5L1RO outside 4L2RO outside 3L3RO outside	6
7LO outside 6L1RO outside 5L2RO outside 4L3RO outside	7
7L1RO outside 6L2RO outside 5L3RO outside 4L4RO outside	8
7L2RO outside 5L4RO outside 6L3RO outside	9
7L3RO outside 6L4RO outside 5L5RO outside	10
7L4RO outside 6L5RO outside	11
7L5RO outside 6L6RO outside	12
7L6RO outside 7L7RO outside	13
	14

Our window and patio products complement our range of other aluminium doors and can be designed to coordinate with each other, for the complete look.

They can also be used on their own to make a unique statement.



Patio Doors, Roof Lantern and Window

OTHER PRODUCTS

Our product offering doesn't end with bifolding doors. We have a full range of other aluminium home improvement products that cater for any project, any style, and any aperture.

Other products include:

- Roof Lanterns.
- Windows.
- Patio Doors.



Bifolding Doors & Roof Lantern

Our Thermal Lantern Roof is the perfect finishing touch to a new extension, such as a kitchen-diner, and also ideal when replacing an existing lantern roof, creating a stylish, light and airy space in the home.

The Roof Lantern System has an innovative thermally broken system, which keeps cool in summer and warm in winter, makes it more thermally efficient than conventional aluminium roof systems.

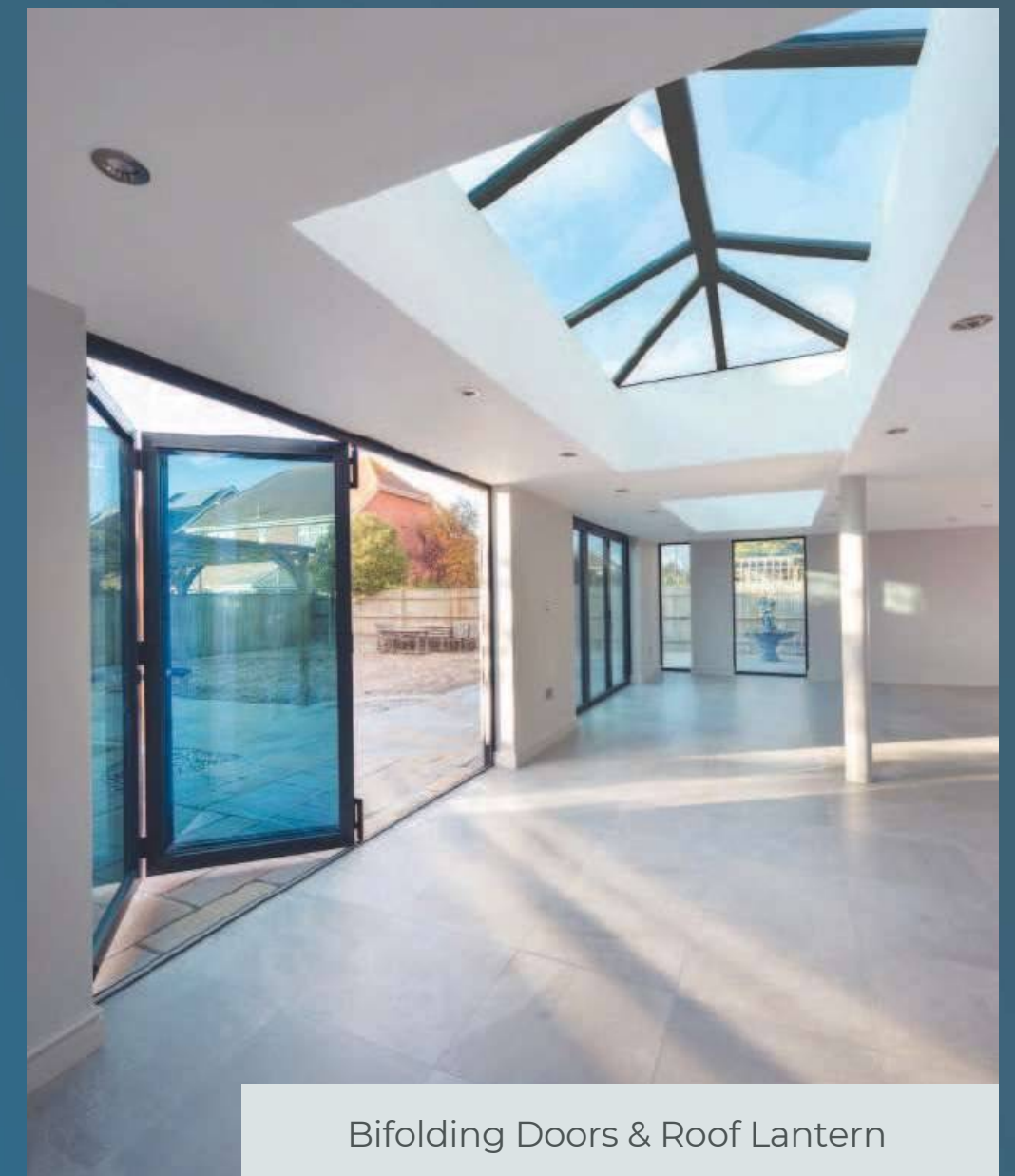

Bifolding Doors & Roof Lantern

quality
**ALUMINIUM
SYSTEMS**

